

# Easy Sampler 1210

Sampling Made Easy



METTLER TOLEDO



# Table of Contents

<b>1</b>	<b>Introduction</b>	<b>3</b>
1.1	Scope of delivery .....	3
1.2	Check on arrival .....	4
<b>2</b>	<b>Safety Information</b>	<b>5</b>
2.1	Definition of signal warnings and symbols.....	5
2.2	Intended use .....	5
2.3	Product specific warnings and symbols.....	5
<b>3</b>	<b>Design and Function</b>	<b>7</b>
3.1	EasySampler 1210 Overview .....	7
3.2	EasySampler 1210 Rear View (with cover).....	7
3.3	EasySampler 1210 Rear View (without cover) .....	8
3.4	Sampling Probe.....	9
3.4.1	Probe Connectors.....	9
3.5	Touchscreen EasySampler 1210 .....	10
3.5.1	EasySampler 1210 Touchscreen Icons.....	11
3.6	Working Principles of EasySampler 1210.....	13
3.6.1	Flow fundamentals of EasySampler 1210.....	13
3.6.2	Solvents of EasySampler 1210.....	14
3.7	How EasySampler 1210 captures, quenches and dilutes a reaction sample .....	15
3.8	EasySampler 1210 Functions .....	15
3.9	LED Status .....	17
<b>4</b>	<b>Installation</b>	<b>18</b>
4.1	Installation requirements.....	18
4.2	Transport the device.....	18
4.3	Install the vial rack.....	18
4.4	Connect the sampling probe.....	19
4.5	Install the needle.....	19
4.6	Connect power to device.....	20
4.7	Check installation of protective dust cap on Ethernet port .....	21
4.8	Turn on device.....	21
<b>5</b>	<b>Operation</b>	<b>22</b>
5.1	Rinse the pump .....	22
5.2	Clean .....	22
5.3	Prepare .....	24
5.4	Take 1 Sample .....	24
5.5	Programming a Sample Sequence .....	25
5.6	Start a sample sequence.....	27
5.7	Change a rack during a sample sequence .....	28
5.8	Taking ad hoc samples during a running sequence .....	28
5.9	Change a running sequence.....	28
5.10	Export sampling data .....	29
5.11	Device Settings.....	30
5.11.1	Export log files.....	32
5.11.2	Determine and setting the real pocket size.....	32
<b>6</b>	<b>Maintenance</b>	<b>33</b>
6.1	Pause during the Operation of EasySampler 1210.....	33
6.2	Checking for Leaks.....	33
6.3	Cleaning the EasySampler 1210 .....	33
6.4	Replace EasySampler 1210 Tubing .....	33
6.4.1	Replace Solvent Feeding lines.....	34
6.4.2	Replace tube set for EasySampler .....	35
6.4.3	Replacing the EasySampler probe head tubing .....	36
6.5	Replace the Needle .....	38
6.6	Sleeve Exchange.....	38
6.6.1	Why it is necessary to exchange a Sleeve? .....	38

6.6.2	Sleeve Mounting and Removal with SMART .....	39
6.7	Replace the 3-way valve.....	44
6.8	Remove blockages.....	44
6.8.1	Determine location of blockage.....	44
6.8.2	Remove blockage in the probe.....	44
6.8.3	Remove blockage in the Solvent tubes, needle or valve .....	45
6.9	Touchscreen Firmware Update.....	45
6.10	Disposal .....	46
<b>7</b>	<b>Troubleshooting</b> .....	<b>47</b>
<b>8</b>	<b>FAQs</b> .....	<b>49</b>
<b>9</b>	<b>Accessories</b> .....	<b>50</b>
9.1	Main Accessories Overview .....	50
9.2	Probe and accessories .....	52
<b>10</b>	<b>Technical Data</b> .....	<b>53</b>
10.1	Solvent compatibility .....	54
10.2	Dimensions.....	54
10.2.1	Device Dimensions .....	54
10.2.2	Probe Dimensions.....	54
<b>11</b>	<b>Certifications</b> .....	<b>56</b>
11.1	Information_Notice_EasySampler_Pressure Directive_2014_68_EU.pdf .....	56







# 1 Introduction

EasySampler 1210 enables automated and unattended sampling of chemical reactions 24/7. The unique sampling probe facilitates sampling of a wide range of chemical reactions with precision, including heterogeneous reactions, reactions at elevated pressure and sub-ambient temperatures, as well as air and moisture sensitive chemistries. The representative samples gained with EasySampler 1210 provide accurate analytical data for improved reaction understanding while increasing chemists' productivity.

Using the EasySampler Connectivity kit you have the EasySampler 1210 functions available on the EasyMax, OptiMax, RX-10 and RC1mx. Additionally sampling information is added to the experiment and is exported with the experiment file.

## 1.1 Scope of delivery

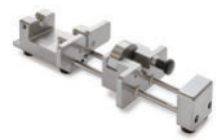
The following items are included in the EasySampler set (30083901):

	Description	Order No.
	EasySampler 1210 System	
	EasySampler 10 mL rack	30040993
	Vial (100 pieces), not assembled	30244745
	Vial (1000 pieces), not assembled	30111624
	Needle	30041011
	Sleeve Mounting And Removal Tool incl. Torx key	30213880
	Waste bottle 500 mL GL55	30072069
	Screw cap for 500 mL waste bottle, GL55	30094594
	Septum for GL55	30306192



Bottle 250 mL with cap, GL45	51191591
Distributor cap, GL45, 2 x GL14	51191972
Screw Cap GL14, without aperture	51190318
Screw cap GL14, with aperture	51190317
Silicone rubber seal	51191170



EasySampler Pump Rinsing Set	30466882
• 1x PTFE tubing	
• 1x Luer locker adapter	
• 1x Syringe (10 mL)	

User Manual  
 USB stick RXE/CSS with documents

There are additional parts that are needed for proper function of the system:

EasySampler Connectivity kit	30110344
------------------------------	----------

### EasySampler probes



EasySampler Probe 210 set	30246344
EasySampler Probe 330 Set	30306933
EasySampler Probe 450 set	30306037

## 1.2 Check on arrival

Check the following conditions once the package has arrived:

- The package is in good condition.
- The contents show no signs of damage (e.g. broken covers, scratches, etc.)
- The contents are complete (see [Scope of delivery Page 3]).

If any one of these condition is not fulfilled, please contact your local support team.

## 2 Safety Information

This device has been tested for the intended purposes described in this document. However, this does not absolve you from the responsibility of performing your own tests of the product supplied by us regarding its suitability for the methods and purposes you intend to use it for. You should therefore observe the following safety measures.

We, Mettler-Toledo GmbH, accept no liability whatsoever if you do not observe the following rules and safety notes for safe operation of the device.

### 2.1 Definition of signal warnings and symbols

Safety notes are marked with signal words and warning symbols. These show safety issues and warnings. Ignoring the safety notes may lead to personal injury, damage to the instrument, malfunctions and false results.

#### Signal words

<b>WARNING</b>	A hazardous situation with medium risk, possibly resulting in death or severe injury if not avoided.
<b>CAUTION</b>	A hazardous situation with low risk, resulting in minor or moderate injury if not avoided.
<b>NOTICE</b>	A hazardous situation with low risk, resulting in damage to the instrument, other material damage, malfunctions and erroneous results, or loss of data.
<b>Note</b>	(no symbol) for useful information about the product.

### 2.2 Intended use

EasySampler 1210 is intended to be operated in a laboratory and used by trained staff. It allows you to sample reactions that do not exceed a viscosity of 3 mPas.

Always operate and use your device in accordance with the instructions contained in this manual; use it only together with equipment specified in this documentation.

Any other type of use and operation beyond the limits of these technical specifications without the written consent from Mettler-Toledo GmbH is considered as not intended.

### 2.3 Product specific warnings and symbols



#### **WARNING**

##### **Risk of electric shock**

- 1 Make sure to plug the power cable supplied into a power supply outlet that is grounded. A technical fault could otherwise result in serious injury or death.
- 2 Only use the METTLER TOLEDO power supply cable and AC power adapter designed for your instrument.



#### **CAUTION**

##### **Potentially explosive environment**

The housing of EasySampler 1210 is not gas tight (explosion hazard due to spark formation, explosion caused by ingress of gases).

- 1 Never work in an environment subject to explosion hazards.
- 2 Avoid electrostatic charge formation.



#### **CAUTION**

##### **Crush Hazard**

An exposed needle can cause personal injuries.

- Do not remove the needle protection shield when EasySampler 1210 is ON.



## NOTICE

### **Risk of blocking fluid paths with solids in sample pocket**

The fluid lines may become blocked if solids in the sample pocket are not dissolved.

- Make sure to select appropriate Quench and Dilution solvents to dissolve the solids within 10 seconds.



## NOTICE

### **Risk of blocking pump with viscous solvents**

Pump blocks at 6 bar pressure.

- Make sure that the viscosity of the solvents used for Quench, Dilution and Reaction is not higher than 3 mPas.



## NOTICE

### **Sampling reaction at elevated pressure**

When using EasySampler 1210 to sample reactions at elevated pressure, do not exceed the operating conditions specified in the EasySampler 1210 technical data section.

For safe operation of the sampling probe, limit the maximum pressure in the reactor using an adequate rupture disc.

The Operating Instructions must be read and understood. Exceeding operating conditions can cause leak of reaction mixture and damage of EasySampler 1210 and/or the sampling probe.



### 3 Design and Function

#### 3.1 EasySampler 1210 Overview

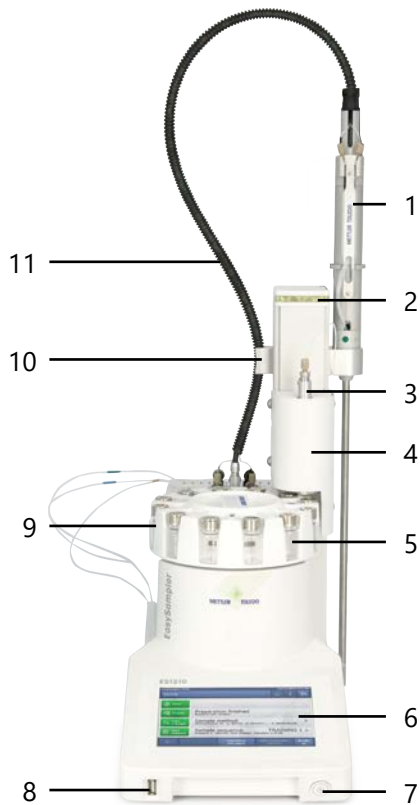

1	Sampling probe	7	Power button
2	Status LED	8	USB port
3	Needle holder	9	Rack (for 12 x 10 mL vials)
4	Needle protection shield	10	Conduit holder
5	Vial (10 mL)	11	Conduit
6	Touchscreen		

#### 3.2 EasySampler 1210 Rear View (with cover)

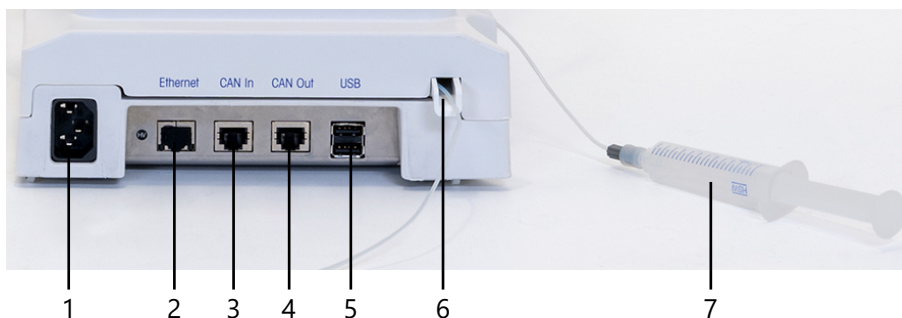

1	Socket for power supply	5	USB ports (1-2)
2	Ethernet connection (with protective dust cap)	6	Drip pan outlet
3	CAN In connection	7	Syringe of rinsing kit
4	CAN Out connection		

### 3.3 EasySampler 1210 Rear View (without cover)

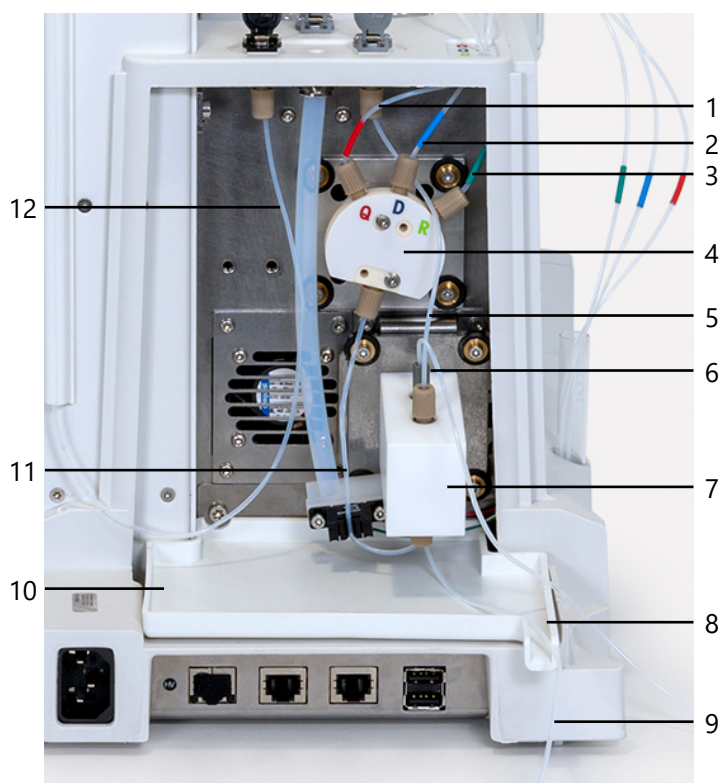

1	Quench solvent line (red)	7	Pump
2	Dilution solvent line (blue)	8	Drip pan outlet
3	Reaction solvent line (green)	9	Waste line of rinsing kit
4	Valve (3-way)	10	Drip pan
5	Fluid line pump to probe	11	Fluid line valve to pump
6	Rinsing kit pump connection	12	Fluid line probe to needle

### 3.4 Sampling Probe

**NOTICE** Do not exchange probe shaft.

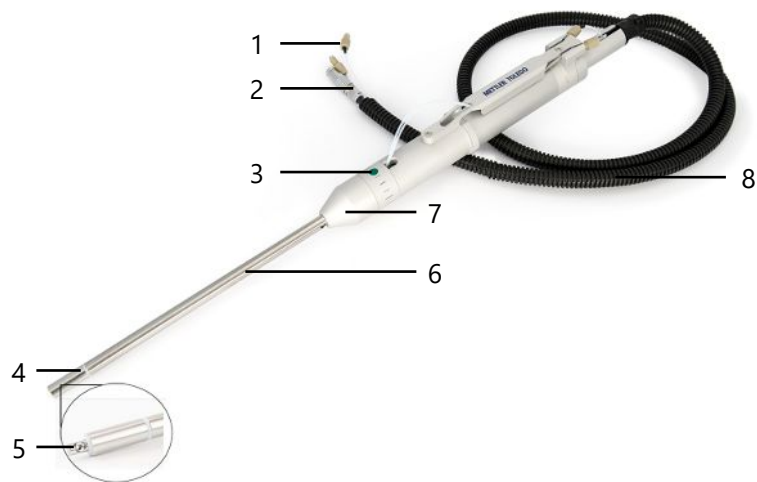

1	Fitting nuts (PEEK)	5	Sample pocket (20 µL)
2	Power cable connector	6	Probe shaft
3	Green dot (indicates pocket direction)	7	Nose piece
4	Sleeve	8	Conduit (PTFE tubing and cable)

#### 3.4.1 Probe Connectors

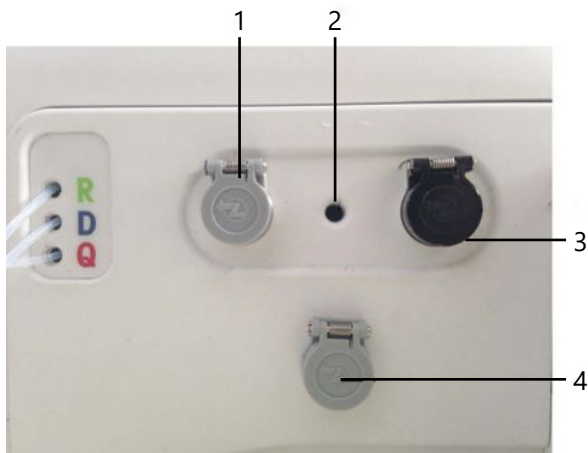

1	Nut connector (fluid line from pump to probe)	3	Nut connector (fluid line from probe to needle)
2	Spill port	4	Probe power cable socket

### 3.5 Touchscreen EasySampler 1210



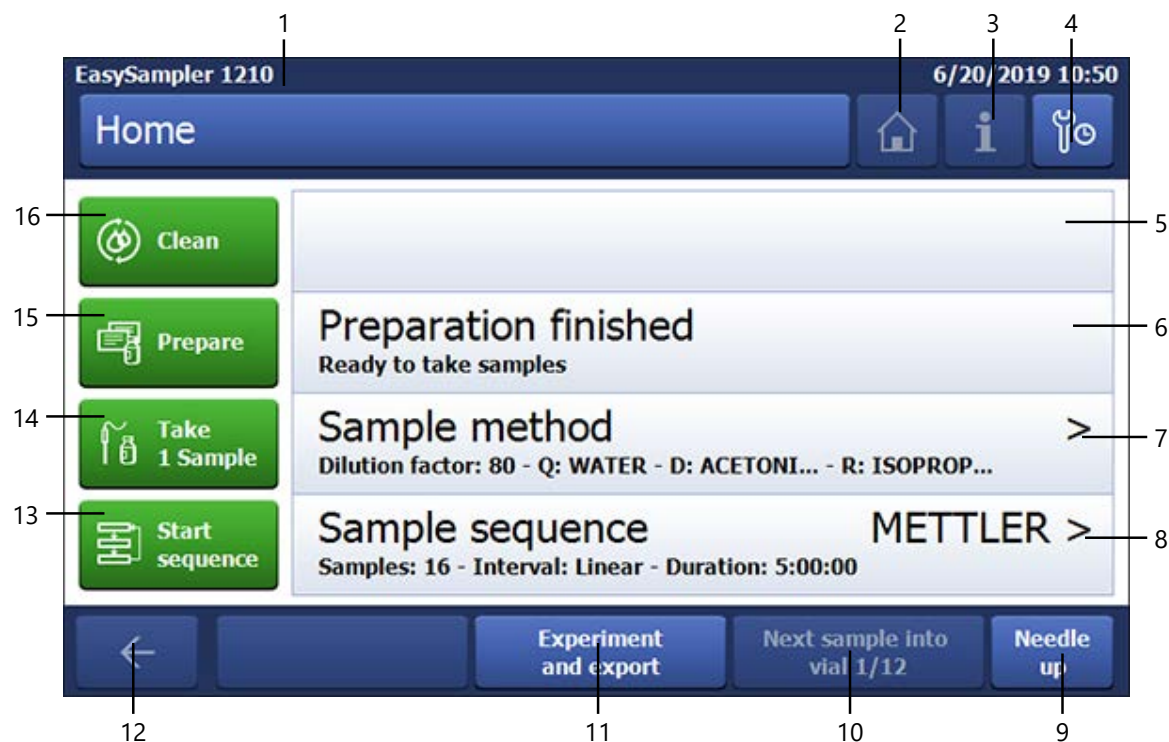





The green buttons on the left side trigger a process and are in the order of the EasySampler 1210 workflow. Next to the process button is the information field, providing more details about the state of EasySampler 1210. If there is an arrow on the right side, parameters can be changed by pressing the white information field. On the bottom, general functions are located.













N.	Description	Field type
1	Running application	Information
2	Home	Action
3	Information about warnings	Action
4	Device Settings	Information / Action
5	Clean: displays current action (process triggered by pushing button 16)	Information
6	Prepare: <ul style="list-style-type: none"> <li>Displays current action and time to next action (process triggered by pushing button 15)</li> </ul>	Information / Action
7	Sample method: <ul style="list-style-type: none"> <li>Allows the user to change Dilution Factor</li> <li>Displays current action (process triggered by pushing button 14)</li> </ul>	Information / Action
8	Sample Sequence: <ul style="list-style-type: none"> <li>Allows the user to setup a new sequence, or use an existing sequence</li> <li>Displays time to next sample (process triggered by pushing button 13)</li> </ul>	Information / Action
9	Needle Up	Action
10	Next vial to transfer the reaction sample in	Information
11	Experiment and export	Action
12	Go back	Action
13	Start Sequence	Action
14	Take 1 Sample	Action
15	Prepare	Action
16	Clean	Action

### 3.5.1 EasySampler 1210 Touchscreen Icons

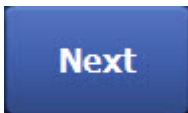
#### Green Icons

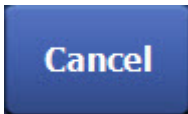
Green Icon	Description	Green Icon	Description
 Clean	The Clean process begins immediately and is used to fill and/or clean the fluid lines before or after sampling a reaction.	 Abort Cleaning	Abort the Cleaning process
 Prepare	Prepare EasySampler 1210 for taking a sample. <ul style="list-style-type: none"> <li>Fills the relevant solvent lines with Quench, Dilution and Reaction solvents</li> <li>Notifies the user when it is time to place the sampling probe into the reactor.</li> </ul>	 Abort Prepare	Abort the Prepare process.
 Take 1 Sample	Take one sample. <ul style="list-style-type: none"> <li>Enable taking 1 sample at any given time</li> <li>Sample is captured, quenched immediately, transferred to a vial and diluted</li> <li>Dilution Factor is user-specified (80 to 450 times the sample volume)</li> </ul>	 Abort Sampling	Abort the Sampling process <ul style="list-style-type: none"> <li>If a running sampling process is aborted, the Prepare process is then required to prepare EasySampler 1210 for a new sampling process.</li> </ul>
 Start sequence	Start a user programmed sequence for unattended sampling. <ul style="list-style-type: none"> <li>Up to 480 samples (from Software version 6.1); 24 samples by default</li> <li>User-specified intervals (specific point in time for sampling, linear, logarithmic)</li> <li>Dilution Factor is user-specified (80 to 450 times the sample volume)</li> </ul>	 Stop sequence	Stop the Sequence <ul style="list-style-type: none"> <li>If a running sampling sequence is aborted, any active sampling process will be completed, but the sequence will stop and no further samples will be taken.</li> </ul>

## Blue Icons

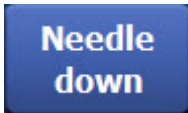
Blue Icon	Description	Blue Icon	Description
	Shows the vial number to be filled next in a sampling sequence		Insert numbers by typing on the keyboard shown in the touchscreen
	Insert text by typing on the keyboard shown in the touchscreen		Go back to the previous step
	Go to the next step		View and enter the device data settings
	Reject the inputs and leave the current window		Apply the current changes
	Information and details if an error occurs. Button only active in case of an error.		Go back to the home window
	<b>Needle up</b> The needle up action is used when you need to exchange a rack: the vials are filled and you need to replace them with empty ones. When performing this action, the needle moves up to the highest position, and allows enough clearance to remove and replace the rack.		
	<b>Needle down</b> When the rack is repositioned with new empty vials, you must perform this action to advance the sequence. The needle will move down and the rack will rotate to position WASTE 1.		

### 3.6 Working Principles of EasySampler 1210

EasySampler 1210 enables unattended, automated sampling of reactions in such a way to provide samples representative of the reaction at the time of sampling. EasySampler 1210 captures a reaction sample, quenches it in place at reaction conditions, and then dispenses and dilutes it into a vial in preparation for offline analysis. This section/chapter describes the details of how EasySampler 1210 works, specifically the fluid flow paths, descriptions of the solvents and how the sampling probe captures and quenches a sample. Following this, the major functions are described, including the steps to prepare the system to take a sample.

#### 3.6.1 Flow fundamentals of EasySampler 1210

EasySampler 1210 is composed of the following major components:

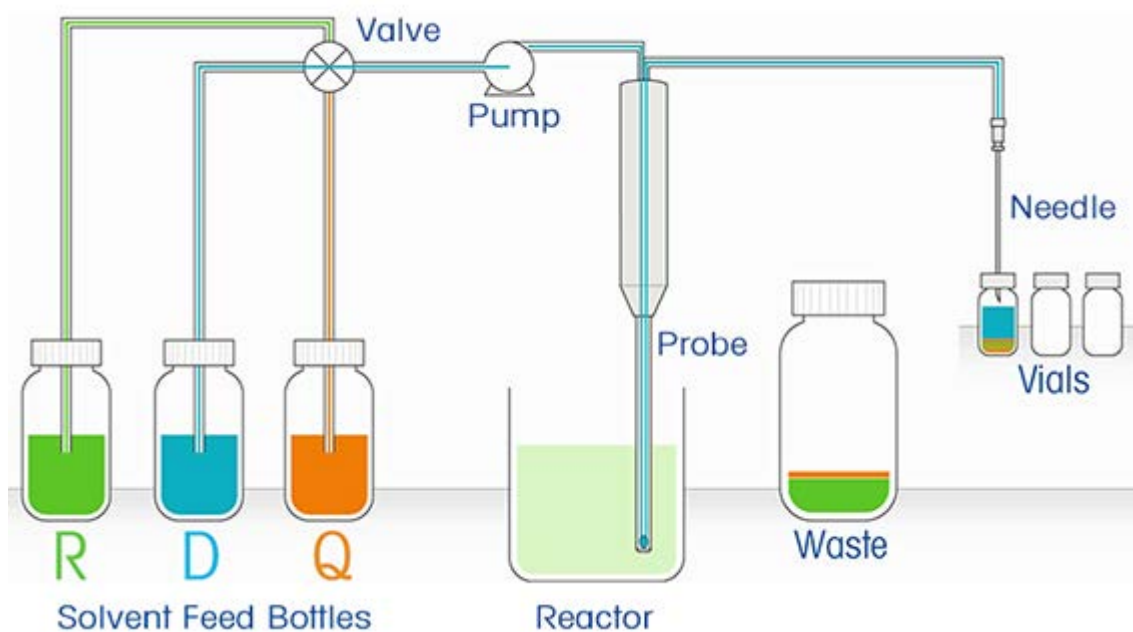

Component	Function
Solvent feed bottles	Contain the solvents for the sampling process R = Reaction solvent (green) D = Dilution solvent (blue) Q = Quench solvent (orange)
Valve	Switches between solvents according to the action triggered
Pump	Pumps the fluids
Sampling probe (with 20 $\mu$ L sample pocket)	Captures, quenches and dilutes a reaction sample
Rack with 12 x 10 mL vials	Contains the vials to be filled with reaction samples
Waste bottle	Disposal of waste solvents
Needle	Fills the vials in the rack, and disposes waste solvent to the waste bottle

Schematics A and B below show the fluid scheme of EasySampler 1210. Solvent is drawn from the solvent feed bottles and the switching valve selects the appropriate solvent to reach the pump. The pump pushes the solvent to the sampling probe, through the sample pocket and out of the sampling probe and through the needle to A) a vial, or B) the waste bottle.

### Schematics of EasySampler 1210 flow scheme

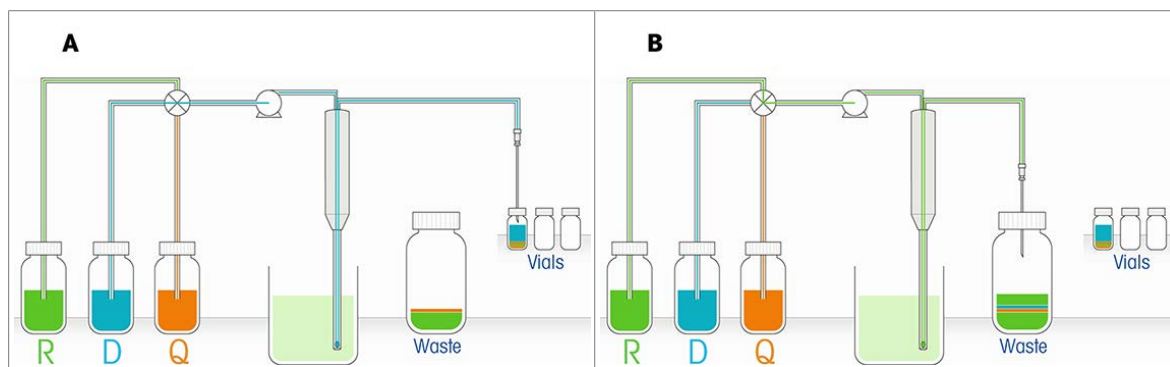

### 3.6.2 Solvents of EasySampler 1210

In the fluid flow process described in the previous chapter, the 3 feed solvents are used as Reaction, Dilution and Quench solvents. The table below describes the function of each solvent.

Solvent	Description
Reaction	<b>Reaction solvent</b> fills the sample pocket prior to taking a sample. When the sample pocket moves out, into the reaction, the <b>Reaction solvent</b> in the sample pocket is displaced with a sample of the reaction. It is advised that the <b>Reaction solvent</b> used as a feed with EasySampler 1210 is the same as the solvent used in the reaction to be sampled because the moving out of the sample pocket will always dispense 20µL of <b>Reaction solvent</b> into the reaction mixture.
Dilution	<b>Dilution solvent</b> is used to dilute the quenched sample to a user-specified concentration in the destination vial.
Quench	<b>Quench solvent</b> is used to quench the reaction sample in the pocket of the sampling probe. The quench step takes place at the point of sampling, and at reaction conditions to provide a sample representative of the reaction at the time of sampling.

The following picture shows how the lines distribute the solvents according to the solvents chosen:

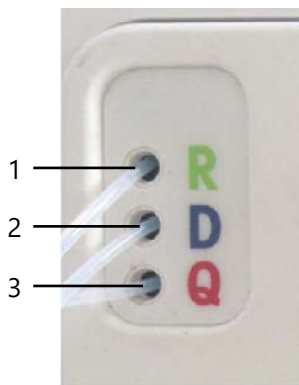

1	Reaction solvent line
2	Dilution solvent line
3	Quench solvent line



### 3.7 How EasySampler 1210 captures, quenches and dilutes a reaction sample

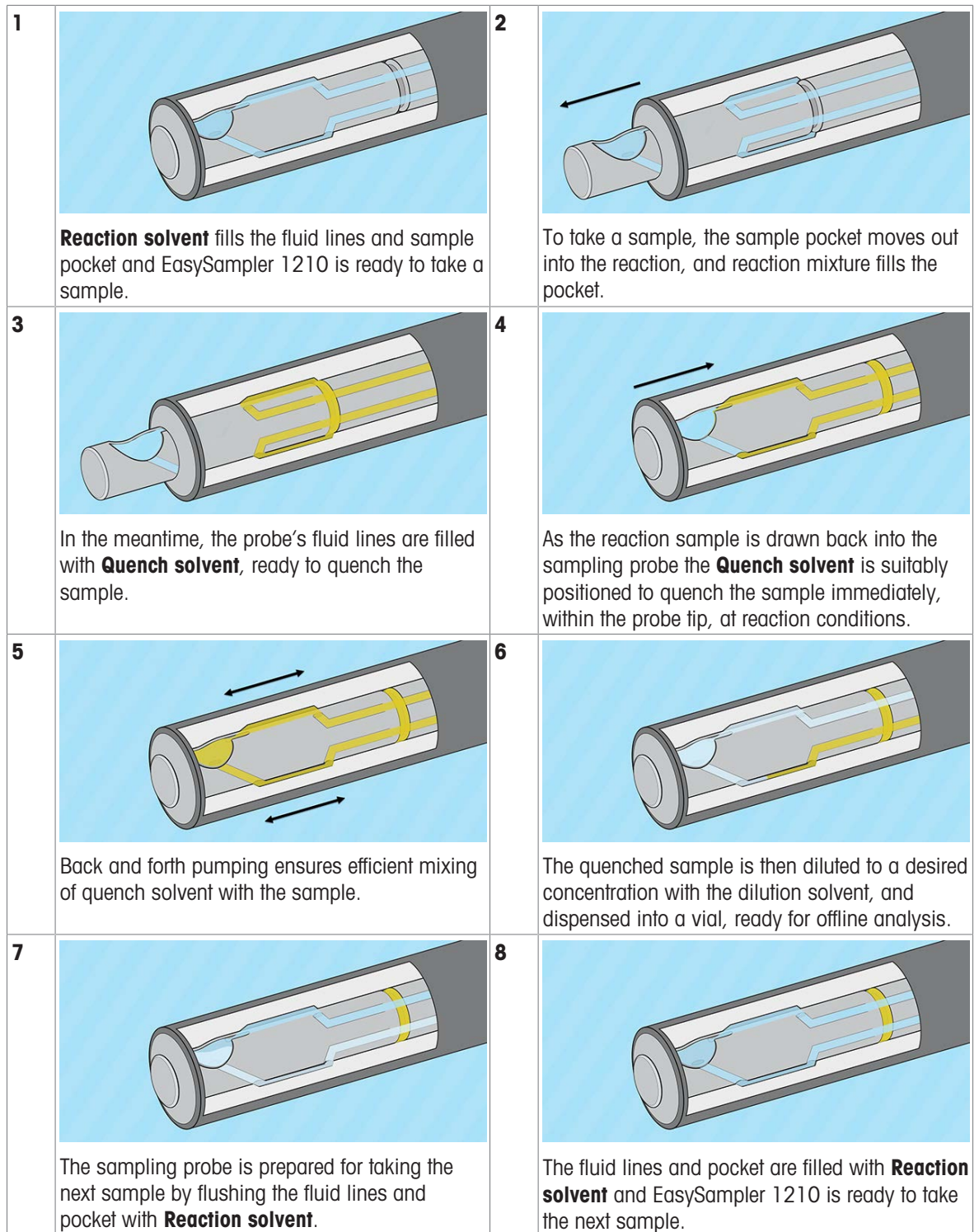

### 3.8 EasySampler 1210 Functions



<p><b>Clean</b></p>	<p>The <b>Clean</b> process ensures the removal of air from the fluid lines, as well as to remove solvents used in previous sampling processes.</p> <p>During the <b>Clean</b> process:</p> <ol style="list-style-type: none"> <li>1. The sample pocket moves to the out position, and the Quench line is flushed.</li> <li>2. The sample pocket moves in, and the Dilution line is flushed, followed by the Reaction line.</li> </ol>
---------------------	--

<b>Prepare</b>	<p>The <b>Prepare</b> process is used to fill the fluid lines with the solvents that will be used in the sampling process, and prepare the sampling probe for insertion into the reactor.</p> <p>During the <b>Prepare</b> process:</p> <ol style="list-style-type: none"> <li>1. The sample pocket moves to the out position and the Quench line is filled with <b>Quench solvent</b>.</li> <li>2. The sample pocket moves back in, and the Dilution and Reaction lines are filled with their respective solvents.</li> <li>3. The pocket is filled with <b>Reaction solvent</b> and the sample pocket moves back out. At this stage the sampling probe is ready to be inserted into the reactor. (See Chapter [Prepare Page 24] for instructions on how to insert a sampling probe into a reactor).</li> <li>4. The sample pocket moves back in, and is filled with <b>Reaction solvent</b>.</li> <li>5. The sampling probe is ready to take a sample.</li> </ol>
<b>Take 1 Sample</b>	<p>The <b>Take 1 Sample</b> process allows the user to take a single sample.</p> <p>During the <b>Take 1 Sample</b> process:</p> <ol style="list-style-type: none"> <li>1. The needle is in a 'Waste' position.</li> <li>2. The sample pocket moves out into the reaction mixture. The <b>Reaction solvent</b> in the sample pocket exchanges with reaction mixture.</li> <li>3. Quench fills the lines and is ready to quench the sample.</li> <li>4. The sample pocket moves back in, and the sample is quenched in place, at reaction conditions.</li> <li>5. <b>Dilution solvent</b> begins to fill the lines.</li> <li>6. The needle moves to a vial, dispenses the quenched sample, and dilutes it according to the user-specified Dilution Factor.</li> <li>7. The needle moves to the waste position and <b>Reaction solvent</b> fills the fluid lines and sample pocket in preparation for taking the next sample.</li> </ol>
<b>Start Sequence</b>	<p>The Start Sequence function starts a user-programmed sequence for unattended sampling. Refer to Chapter [Programming a Sample Sequence Page 25] for details on programming a sequence.</p>

To ensure correct function and prevent contamination of the reaction, EasySampler 1210 requires a **Clean** process, followed by a **Prepare** process before allowing the first sample to be taken.

### 3.9 LED Status

The LED is positioned at the top of the tower and shows the status of the instrument while operating. The table below shows the different possible status of the instrument:

LED Status	Description
	<p><b>GREEN (steady)</b> Instrument is ON and ready for a process (Clean, Prepare, Take 1 Sample or Start sequence).</p> <p><b>GREEN (blinking)</b> EasySampler 1210 is completing a process (Clean, Prepare, Take 1 Sample).</p>
	<p><b>ORANGE (steady)</b> Firmware is being updated.</p>
	<p><b>RED (steady)</b> Error. The errors will be displayed on the touchscreen, with suggested steps to resolve the issues. Sampling processes are aborted.</p>

## 4 Installation

### 4.1 Installation requirements

#### Site requirements

The instrument has been developed for indoor operation in a well-ventilated area. Avoid the following environmental influences:

- Conditions outside of the ambient conditions specified in the technical data
- Powerful vibrations
- Direct sunlight
- Corrosive gas atmosphere
- Explosive atmosphere of gases, steam, fog, dust and flammable dust
- Powerful electric or magnetic fields

### 4.2 Transport the device

To transport the device from one laboratory workplace to another, please proceed as follows:

- 1 If EasySampler 1210 has been in use before, run a **Clean** process.
- 2 Carry EasySampler 1210 only with two hands gripping the front and back handles.



### 4.3 Install the vial rack

- 1 Assemble the vials by mounting the caps.
- 2 Insert the vials into the rack. Ensure they are properly inserted.



- 3 Align the blue arrow on the rack with the blue arrow on EasySampler 1210.



- 4 Rotate the rack lever clockwise to lock it in place.



#### 4.4 Connect the sampling probe

- 1 Place the sampling probe into its holder and ensure it is securely positioned. For probes 450 and 330 use the vial adapter for fixation.



- 2 Secure the conduit to the conduit holder.



- 3 Connect the sampling probe lines (grey line to the grey port and black line to the black port; to avoid leaks, screw the fitting nuts in until you hear a "click" ).
- 4 Connect the probe power cable to the socket.



#### 4.5 Install the needle

- 1 Carefully insert the needle into its holder.



2 Fix the needle in place with the knurled screw.



3 Connect the fitting nut to the needle and screw the fitting nut in until you hear a "click".



4 Mount the needle protection shield, taking care not to pinch the tubing.



## 4.6 Connect power to device



### **WARNING**

#### **Risk of electric shock**

- 1 Make sure to plug the power cable supplied into a power supply outlet that is grounded. A technical fault could otherwise result in serious injury or death.
- 2 Only use the METTLER TOLEDO power supply cable and AC power adapter designed for your instrument.

- 1 Connect the power cable on the rear of the device (100 – 240 V, 50/60 Hz).
- 2 Insert the plug of the power cable into a grounded power outlet that is easily accessible.



## 4.7 Check installation of protective dust cap on Ethernet port



### NOTICE

#### Damage to instrument when CAN cable connected to Ethernet port

The electronics of the device might be damaged so that servicing the device might not be possible anymore.

- 1 Do not remove the dust cap.
- 2 Make sure the dust cap is installed during operation.

The field service engineer needs to remove the dust cap for service activities, please check that it is re-installed after the service activity.

## 4.8 Turn on device

- Press the power button on the front of the device.
- ➔ EasySampler 1210 requires a **Clean** process.



## 5 Operation

### 5.1 Rinse the pump

To ensure good operation of the pump a manual rinsing before and after each experiment is recommended. Use the EasySampler Pump Rinsing Set (30466882) for the manual rinsing of the pump. Once installed the rinsing set can remain connected during normal operation.

For more instructions on rinsing the pump go to [mt.com\EasySampler](http://mt.com/EasySampler). Select the Support tab and watch the video: How to install and use the EasySampler Pump Rinsing Set.

- The pump rinsing set is installed.
  - 1 Place the long waste tubing into a waste receptacle.
  - 2 Choose a solvent capable of dissolving any potential solids.
  - 3 Fill the syringe with the solvent.



- 4 Re-connect the syringe to the luer locker adapter.
- 5 Start a **Clean** process from the touchscreen.
- 6 While **Clean** process is running, push the solvent (30 mL) in the syringe through the upper rinse port.



- 7 If needed repeat the procedure with another solvent.
- 8 Execute a final rinsing with isopropanol while **Clean** is still running.



### 5.2 Clean

**Note** The sampling probe is not yet inserted in the reactor.

Perform a pump rinsing during a **Clean** process to avoid blockages of the EasySampler.

- 1 Select **Clean**.



2 Follow the instructions on the touchscreen and press **OK**.

➔ EasySampler 1210 starts the **Clean** process.

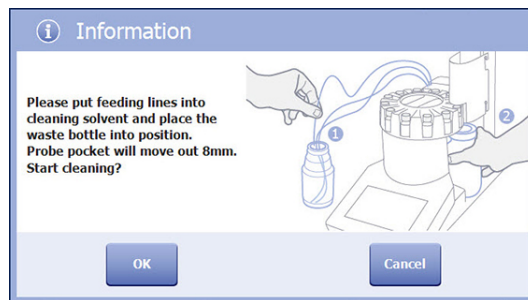



➔ Once the **Clean** process is finished, the **Prepare** button becomes active.

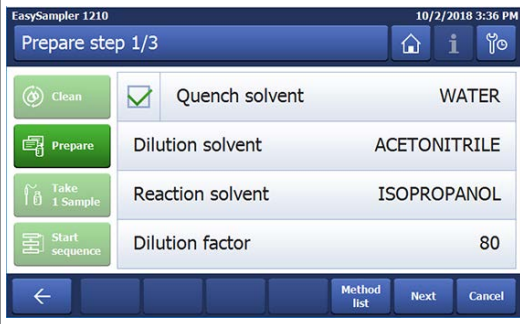
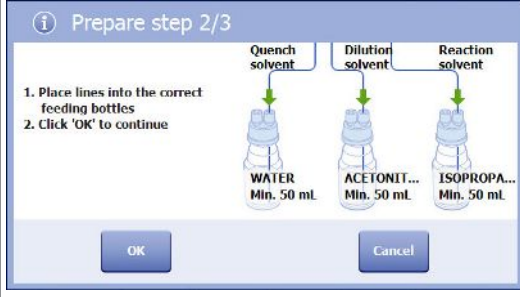
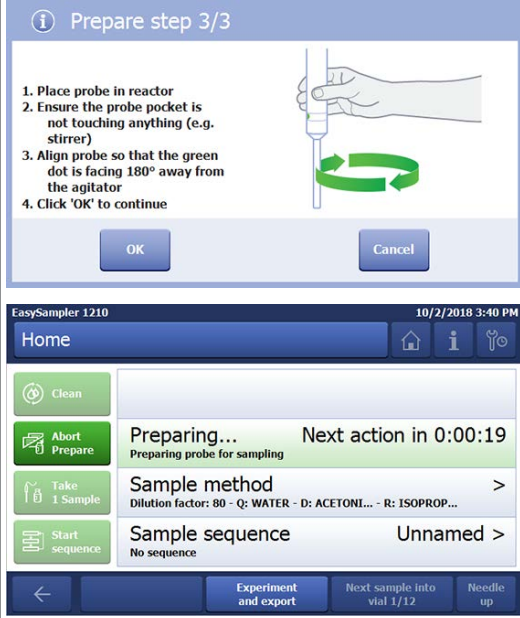

## 5.3 Prepare

**Note** The sampling probe is not yet inserted in the reactor.

<ol style="list-style-type: none"> <li>1 Select <b>Prepare</b>.</li> <li>2 Enter the <b>Quench solvent</b> (if no <b>Quench solvent</b> is selected, <b>Dilution solvent</b> is used instead).</li> <li>3 Enter the <b>Dilution solvent</b>.</li> <li>4 Enter the <b>Reaction solvent</b>.</li> <li>5 Enter a <b>Dilution Factor</b> between 80 and 450.</li> <li>6 Select <b>Next</b>.</li> </ol>	
<ol style="list-style-type: none"> <li>7 Follow the instructions on the touchscreen.</li> <li>8 Select <b>OK</b>. <ul style="list-style-type: none"> <li>➔ EasySampler 1210 starts a <b>Prepare</b> process to fill all feeding lines with the relevant solvents.</li> <li>➔ The touchscreen indicates the time to place the sampling probe into the reactor and the pocket will move out (8 mm).</li> </ul> </li> </ol>	
<ol style="list-style-type: none"> <li>9 Loosen the collar (with the green dot) on the probe headpiece and align the green dot with the pocket.</li> <li>10 Tighten the collar.</li> <li>11 Fit an appropriate adapter onto the sampling probe.</li> <li>12 Carefully insert the sampling probe into the EMPTY reactor.</li> <li>13 Adjust the height of the sampling probe in the reactor so that the probe tip remains clear of any other inserts, stirrer and reactor wall.</li> <li>14 Tighten the adapter onto the sampling probe so that the height of the probe in the reactor is fixed.</li> <li>15 Remove the sampling probe from the reactor.</li> <li>16 Select <b>OK</b>. <ul style="list-style-type: none"> <li>➔ EasySampler 1210 fills the lines and sample pocket with <b>Reaction solvent</b>.</li> </ul> </li> </ol>	
<ol style="list-style-type: none"> <li>17 Prepare the reactor for the reaction by adding the necessary solvents, starting materials and reagents.</li> <li>18 Place the sampling probe into an appropriate port of the reactor lid and turn the sampling probe so that the sample pocket (indicated by the green dot) faces 180° away from the stirrer. <ul style="list-style-type: none"> <li>➔ The position of the pocket will ensure accurate and reproducible sampling of heterogeneous reactions.</li> </ul> </li> <li>19 Ensure the probe tip is immersed in the reaction mixture. <ul style="list-style-type: none"> <li>➔ EasySampler 1210 is now ready to take samples.</li> </ul> </li> </ol>	

## 5.4 Take 1 Sample

- 1 Select **Take 1 Sample**.

- 2 Confirm the sample method with **OK** or change by pressing **Cancel**.
- ➔ EasySampler 1210 starts sampling and the touch-screen displays the remaining time and the activity of the device.

EasySampler 1210 is ready to take further samples as soon as the sampling process is finished.

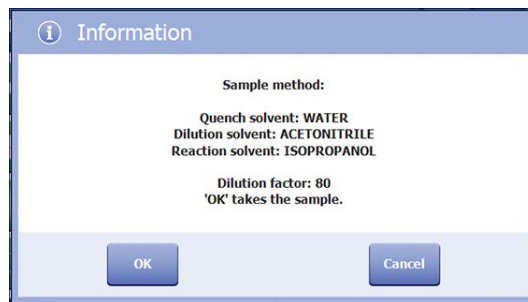

## 5.5 Programming a Sample Sequence

A sample sequence can be pre-programmed and must have at least 2 samples.

<p>1 Select <b>Sample sequence (white button)</b>.</p> <div style="border: 1px solid gray; padding: 5px; margin-top: 10px;"> <p><b>Sample sequence</b> Unnamed &gt;</p> <p>No sequence</p> </div>	
<p>2 Select <b>New sequence</b>.</p> <div style="border: 1px solid gray; padding: 5px; margin-top: 10px; text-align: center;"> <p><b>New sequence</b></p> </div>	
<p>3 Select <b>Sequence name</b> and enter an appropriate sequence name.</p> <p>4 Press <b>OK</b> to confirm.</p> <div style="border: 1px solid gray; padding: 5px; margin-top: 10px;"> <p><b>Sequence name</b> Unnamed</p> </div>	
<p>5 Select <b>Number of samples</b> and enter the number of samples to be taken during the experiment.</p> <p>6 Press <b>OK</b> to confirm.</p> <ul style="list-style-type: none"> <li>• If more than 12 samples are selected, EasySampler 1210 will ask for a rack change after sample 12.</li> </ul>	

7 Select **Type of interval** and choose if the samples are spread in a linear or exponential way over the time of the sequence.

Type of interval Linear

8 Select **Sequence duration** and enter the duration of the sequence.  
 9 Press **OK** to confirm.  
 ➔ A sampling schedule appears.

Sequence duration 7:00:00

10 Press **Apply & save** to return to the homescreen.

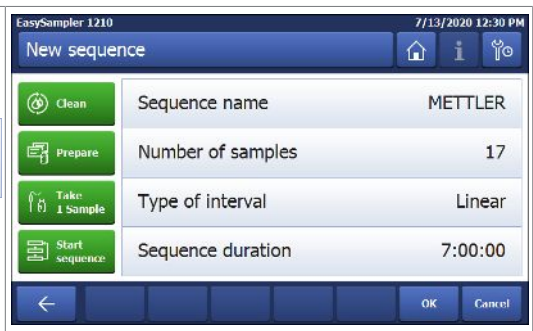

## 5.6 Start a sample sequence

- 1 Select a sequence by tapping on the information field.
- 2 Select sequence list and choose one of the prepared sequences.
- 3 Select **Start sequence**.



- 4 Enter the delay before initiating the process.
  - 5 Tap **OK**.
- ➔ The sequence is running.

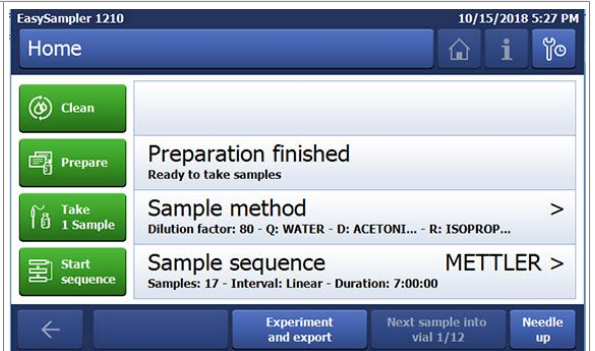

## 5.7 Change a rack during a sample sequence

A rack exchange during a running sequence is possible as long as no sample is taken.

- 1 Press **Needle up**.
- 2 Follow instructions in [Install the vial rack Page 18].
- 3 Press **Needle down**.



## 5.8 Taking ad hoc samples during a running sequence

If there is enough time available to complete the sampling process before the next scheduled sample, EasySampler 1210 will allow the user to take an ad hoc sample. The **Take 1 Sample** will be green.

The time needed depends on the **Dilution Factor** and is between 2 min 52 sec and 4 min 20 sec for a **Dilution Factor** of 80 and 450 respectively.

- 1 Select **Take 1 Sample**.
  - ➔ The sample method is displayed.
- 2 Select **OK** to confirm or select **Cancel** to change **Dilution Factor**.

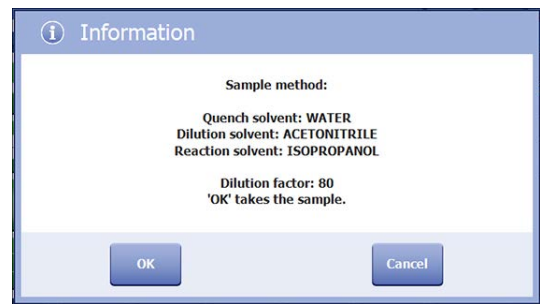

- ➔ EasySampler 1210 takes the ad hoc sample and is ready for the next pre-programmed sample.

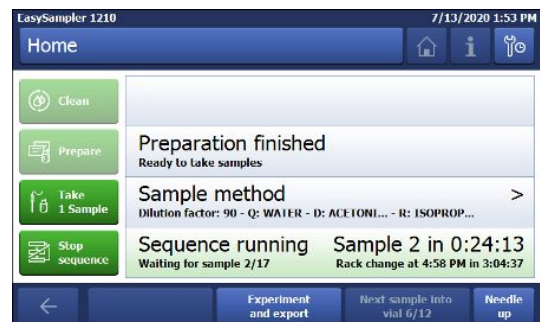

## 5.9 Change a running sequence

**Note** Changing a running sequence is only possible using Firmware version 5.5.0.0 or higher.

Remaining samples in an active sequence on EasySampler 1210 can be changed. Completed samples are grey.

- Sampling times or Dilution Factors can be changed
- Samples can be added to or deleted from the sequence

On a running sequence, press the button **Sequence running**.

**Sequence running**    **Sample 2 in 0:24:13**  
 Waiting for sample 2/17    Rack change at 4:58 PM in 3:04:37



- Change **Dilution Factor** or time of any sample scheduled to be run, add or delete samples.
  - Confirm changes by pressing **Apply & save**. The changes will be applied.
- Apply & save**
- or
- Discard changes by pressing **Cancel**.



## 5.10 Export sampling data

- 1 Insert a USB stick into a USB port on EasySampler 1210.
  - 2 Select **Experiment & Export**.
- Experiment and export**



- 3 Select **Single samples** to export all Single samples in the list into one report file.
- or
- 4 Select **Experiments and sequences** to export all samples of that sequence into one report file.



- 5 Select **Export** and all selected sampling information will be exported to the USB stick.
    - ➔ The sampling information has been exported to the USB stick.
  - 6 Remove the USB stick
- Export**

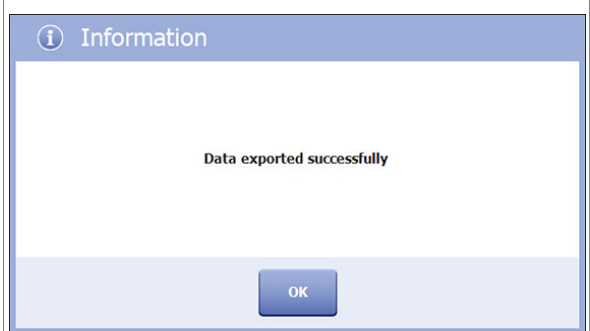

## 5.11 Device Settings

The system will inform the when a sleeve exchange or service is needed.

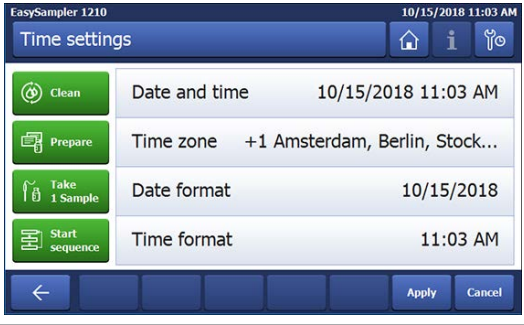
<p>Select <b>Settings</b>.</p> 	
<p>Select <b>Time settings</b>.</p> <p>You can manually set:</p> <ul style="list-style-type: none"> <li>• Date and time</li> <li>• Time zone</li> <li>• Date format</li> <li>• Time format</li> </ul>	
<p>Select <b>Language settings</b>.</p> <p>You can select Language and Keyboard format. The firmware language is available in:</p> <ul style="list-style-type: none"> <li>• English</li> <li>• German</li> <li>• French</li> <li>• Spanish</li> <li>• Chinese</li> <li>• Japanese</li> </ul>	
<p>Select <b>System information</b>.</p> <p>In this section you can retrieve detailed information about EasySampler 1210 and the Sampling probe.</p>	
<p>Information about EasySampler 1210.</p>	



### Information about Sampling probe.

Here you can retrieve information about:

- Device data (Probe Model, Serial Number, and number of total pocket movements)
- Service (date of last service, number of pocket movements since last service)
- Sleeve change
  - Date of last sleeve change
  - Number of pocket movements since the sleeve change
  - Reset the pocket counter to 0 when changing the sleeve

Set the following parameter:

- Real pocket size



### 5.11.1 Export log files

It may be possible that the support team will ask you to send them the log file of the device.

- 1 Select .
- 2 Select **System information**.
- 3 Insert a USB stick in any USB port.

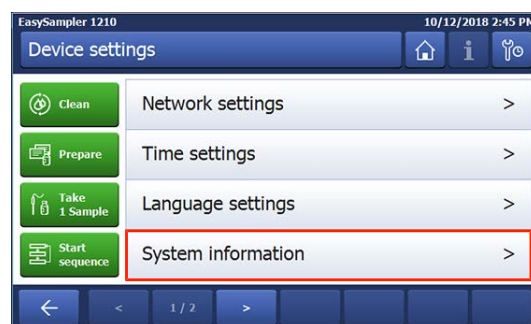

- 4 Select **Export logfile**.
- 5 Remove the USB stick.

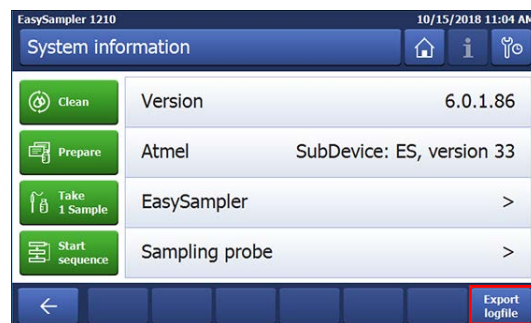

### 5.11.2 Determine and setting the real pocket size

#### Determine the real pocket size

If you quantify the actual pocket size record the volume to EasySampler this volume will be exported in the sampling information file.

The pocket size of the EasySampler probe is 20  $\mu\text{L}$ , with a manufacturing tolerance of up to 10 %. Thus, the sampling pockets of 2 adjacent units can be 18  $\mu\text{L}$  and 22  $\mu\text{L}$ . For quantitative analysis, the pocket size is important. To determine the **Real pocket size**, use the following procedure:

- 1 Make up a solution with a known accurate concentration of a marker.
- 2 Take a sample and analyze.
- 3 Back-calculate the pocket size based on the Area Counts data.

#### Setting the real pocket size

The **Real pocket size** can be defined on EasySampler, and the information will be stored on the probe (on an embedded chip). This information will appear in report files, but will not affect the volume of dilution solvent used (i.e. the Dilution Factor assumes a pocket size of 20  $\mu\text{L}$ ).

- 1 Tap .
- 2 Tap **System information**.
- 3 Tap **Sampling probe**.
- 4 Select **Real size pocket**.
- 5 Enter the determined pocket size.

## 6 Maintenance

This section describes simple routine checks and maintenance procedures that are easily performed by the user to ensure optimal system performance. Regular checks and maintenance ensure the proper function of EasySampler 1210.

Maintenance tasks have to be performed in accordance with the instructions given in this chapter. After performing any maintenance tasks, it should be ensured that the device still meets all safety requirements.

Ask your local support team for the service contract option to ensure continuous running and reliable performance of the device.

### 6.1 Pause during the Operation of EasySampler 1210

If EasySampler 1210 has been switched off for 24 hours, a **Clean** process is recommended before starting a sampling process. This will ensure no bubbles are present in the solvent lines. A **Prepare** process is then required.

### 6.2 Checking for Leaks

Check that all fluid line connectors are tight and in good condition. "Click and fit" connectors are used on all EasySampler 1210 fittings. To ensure a seal is achieved, the fitting must be tightened until an audible click is heard.

### 6.3 Cleaning the EasySampler 1210



#### NOTICE

##### Damage to the device due to incompatible cleaning agents

Inappropriate cleaning agents could damage the housing of the device.

- 1 Use the described cleaning agent.
- 2 Should you use other cleaning agents, ensure that they are compatible with the housing material.

The housing of the instrument is not watertight (i.e. splash proof). We therefore recommend that you clean the housing with a cloth soaked in a mild solvent such as isopropanol or ethanol.

If you have questions about the compatibility of cleaning agents, contact your authorized METTLER TOLEDO dealer or service representative.

### 6.4 Replace EasySampler 1210 Tubing

If tubing is cut, pierced, crimped or damaged in any other way it should be replaced. You have access to all the tubing on EasySampler 1210.



#### NOTICE

##### Cutting and shorting tubes leads to wrong sample size

The correct sampling can only be achieved if tubes are unchanged and used in the correct sample probe type.

The following lines can be replaced:



- Solvent feed lines to valve (PTFE tube set to solvents, PEEK fittings (30246341))
- Tube set for EasySampler (PTFE Tube set for EasySampler, PEEK fittings (30246340))
- Tube set for Probe

For all order numbers check [Accessories Page 50]

## 6.4.1 Replace Solvent Feeding lines

Follow the sequence to replace the solvent feed lines:

For more instructions on changing solvent lines go to [mf.com\EasySampler](http://mf.com\EasySampler). Select the Support tab and watch the video: Change the Solvent Tubing.

Description	Sequence
<ul style="list-style-type: none"><li>■ Wear gloves</li></ul> <ol style="list-style-type: none"><li>1 Start a <b>Clean</b> process from the touchscreen.</li><li>2 Switch off EasySampler 1210.</li><li>3 Remove the rear cover of EasySampler 1210.</li></ol>	
<ol style="list-style-type: none"><li>4 Unscrew the fitting nuts of the solvent lines (marked red, blue and green) from the top of the valve.</li></ol>	
<ol style="list-style-type: none"><li>5 Pull the line till it is completely removed from the EasySampler 1210.</li><li>6 Thread the new solvent line through the respective holes and fit the nut to the corresponding port on the valve.</li><li>7 Make sure the color of the tag matches the color on the valve.</li><li>8 Tighten the connectors with an audible click to confirm tight fitting.</li><li>9 Start a <b>Clean</b> process from the touchscreen.</li></ol>	

## 6.4.2 Replace tube set for EasySampler

- 1 Start a **Clean** process from the touchscreen.
- 2 Remove the rear cover of EasySampler 1210.



- 3 Remove tube from valve to pump.



- 4 Remove tube from pump to probe inlet (grey line).



- 5 Remove tube from needle to probe outlet (black line).



6 Connect the new tube from the valve to pump.



7 Connect the new tube from the pump to probe inlet (grey line). Ensure the color matches to the adapter lid.



8 Connect the new tube from needle to probe outlet (black line).

9 Turn until there is an audible click to confirm that the connection is tight.

10 Put the rear cover back in place.

11 Start a **Clean** process from the touchscreen.



### 6.4.3 Replacing the EasySampler probe head tubing

You can find a how to video on [mf.com/EasySampler](http://mf.com/EasySampler) under the Support tab: Replacing the EasySampler probe head tubing.

- Two wrenches are needed (4 and 5.5 mm)
  - The sampling probe is disconnected from the device
  - The probe shaft is removed from the probe head
- 1 Remove the sleeve and pull back the outer tube.
  - 2 Locate the two notched cutouts on the inner shaft.
  - 3 Use the wrenches on the cutouts to separate the sampling head from the sampling probe.



4 Manually unscrew the probe tube and pull back to reveal the tubing.



5 Remove tubing by pulling it off the prongs of the sampling head.



6 Pull the tubing through the inner tube to remove it.

7 Discard the old tubing.

8 Expand the new tubing set slightly by using a tooth pick.



9 Thread the new tubing through the inner shaft.

10 Thread the tubing into the outer shaft and pull the inner shaft through the outer shaft.



11 Orient the sampling head so that the pocket is facing up.



12 Connect the grey fluid line to the top prong.

13 Connect the black fluid line to the bottom prong.



14 Screw the sampling head back onto the probe shaft.





15 Use the two wrenches to tighten.



## 6.5 Replace the Needle

Follow the sequence below.

For more instructions on replacing the needle go to [mt.com\EasySampler](http://mt.com/EasySampler). Select the Support tab and watch the video: Replace the Needle.

Description	Sequence
<ol style="list-style-type: none"><li>1 Select <b>Needle up</b> on touchscreen.</li><li>2 Switch off EasySampler 1210.</li><li>3 Remove needle protection shield.</li></ol>	
<ol style="list-style-type: none"><li>4 Disconnect the line from the needle.</li></ol>	
<ol style="list-style-type: none"><li>5 Loosen the knurled screw.</li></ol>	
<ol style="list-style-type: none"><li>6 Replace the old needle with a new one. See [Install the needle Page 19].</li></ol>	

## 6.6 Sleeve Exchange

### 6.6.1 Why it is necessary to exchange a Sleeve?

EasySampler sleeves are consumable items consisting of PTFE and Alloy C-22. PTFE expands, contracts and flows with changes in temperature. The Alloy C-22 sample head moves in and out causing a wear on the PTFE. Even mild abuse - scratching the inside of the sleeve, improper mounting, or other physical impacts - can potentially lead to sleeve failure and result in Quench solvent leaking into the reaction. The proper function of a sleeve between -20 and 140 °C at ambient pressure is guaranteed for 100 samples (200 pocket moves). If samples are taken at elevated pressure, a sleeve change is needed after each experiment (up to 24 samples). For pressure experiments also check the limits indicated in the [Technical Data Page 53].



Users can check pocket moves on the EasySampler touchscreen (Settings -> System Information -> Sampling probe -> Sleeve change).

## 6.6.2 Sleeve Mounting and Removal with SMART

The mounting and removal of the probe sleeves is done with the so called Sleeve Mounting and Removal Tool (SMART).

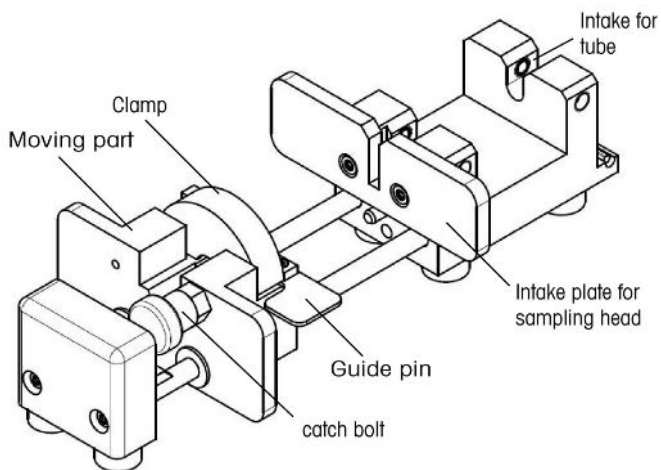

The SMART is made of Stainless Steel and has been specifically designed to enable users to remove used sleeves and mount new sleeves while **avoiding damage to the sample pocket and the new sleeve**.















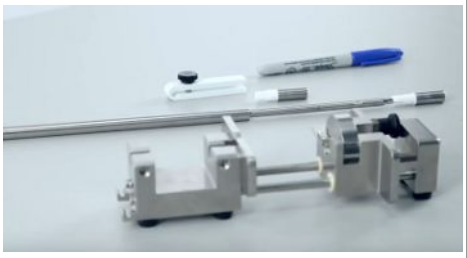

For more instructions on changing and mounting the sleeve go to [mt.com/EasySampler](http://mt.com/EasySampler). Select the Support tab and watch the video: Change a Sleeve on the New Style EasySampler Probe.







Follow the sequence to remove a used sleeve and mount a new sleeve.





**NOTICE** Wear gloves while performing this action.

Description	Sequence
<ul style="list-style-type: none"> <li>■ A <b>Clean</b> process was performed.</li> <li>■ The sampling probe is disconnected from EasySampler.</li> </ul> <ol style="list-style-type: none"> <li>1 Unscrew the connectors.</li> </ol>	
<ol style="list-style-type: none"> <li>2 Slide the PTFE tubing out from the tube cover.</li> </ol>	
<ol style="list-style-type: none"> <li>3 Unscrew and remove the nosepiece and collar.</li> </ol>	

<p>4 Remove the nose clamp with the supplied Torx key.</p>	
<p>5 Remove the probe shaft.</p>	
<p>6 Hold the probe tip and turn the probe's outer tube to separate the shaft from the sleeve.</p>	
<p>7 Pull the outer tube back approximately 2 inches (5 cm).</p>	
<p>8 Gather the SMART, probe shaft and new sleeve.</p>	
<p>9 Slide the moving part of the SMART to reach the sample head intake.</p>	
<p>10 Pull and turn the locking bolt and open the clamp.</p>	

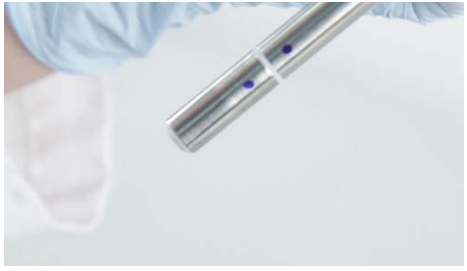
<p>11 Insert the probe shaft into the SMART, and snap it in place. (The probe has cut-outs, above the sleeve, to fit into the SMART).</p>	
<p>12 Close the clamp.</p>	
<p>13 Pull the moving part back to remove the used sleeve from the probe shaft.</p>	
<p>14 Using two hands, remove the probe shaft from the SMART.</p>	
<p>15 Release and discard the used sleeve.</p>	
<p>16 Take a new sleeve and align a slot of the sleeve with the guide pin of the SMART.</p>	
<p>17 Close the clamp and lock the sleeve in place.</p>	
<p>18 <b>Remove the pin.</b></p>	

<p>19 Pull the moving part back.</p>	
<p>20 Insert the probe shaft in the SMART and snap it in place.</p>	
<p>21 Slowly push the sleeve onto the probe shaft.</p>	
<p>22 Open the clamp.</p>	
<p>23 Using two hands, remove the probe shaft from the SMART with the sleeve in place.</p>	
<p>24 To fit the outer tube, hold the probe tip and turn the outer tube.</p>	
<p>25 Slide the solvent lines through the Sleeve Mounting Clamp.</p>	

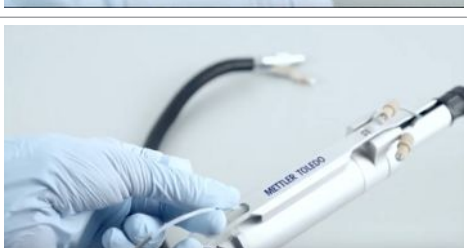
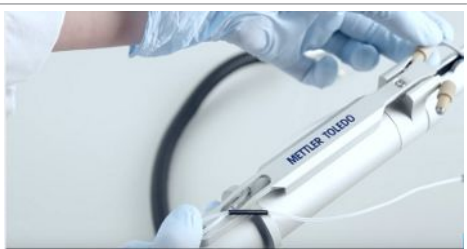
<p>26 Push the Sleeve Mounting Clamp over the inner tube and tighten the screw.</p> <p>27 Hold the Sleeve Mounting Clamp and turn the outer tube.</p>	
<p>28 Turn until there is no gap.</p> <p>29 Mark position on sleeve and outer tube.</p> <p>30 Tighten the tube for another half turn.</p> <p>31 Remove the Sleeve Mounting Clamp.</p> <p>32 Clean off marks on sleeve and outer tube.</p>	
<p>33 Fit the probe shaft onto the probe head by aligning the pins with the cutouts.</p>	
<p>34 Fit the nosepiece in place and tighten the screws.</p>	
<p>35 Replace the collar and nosepiece, careful to avoid crimping PTFE lines.</p> <p>36 Align the pocket to the green dot. For optimal sampling results the sampling probe pocket has to face 180° away from the agitator. The orientation of the sampling probe pocket can easily be verified by the orientation of the green dot.</p>	
<p>37 Place PTFE lines in the guide and connect the matching color-coded piece.</p>	
<p>38 The connector must "CLICK" to be tight.</p>	

- 39 Gently slide the tubing under the tubing cover.
- 40 Place the sampling probe back onto the holder.
- 41 Connect the probe's power cable and matching color-coded solvent tubing to EasySampler 1210.
- 42 Reset the pocket counter to zero.

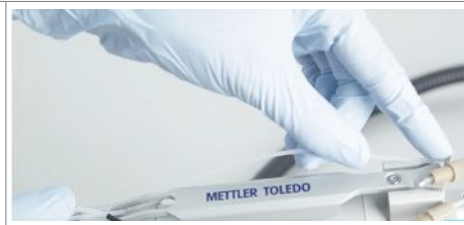

## 6.7 Replace the 3-way valve

A broken 3-way valve can be replaced, please contact your trained field service engineer to perform this task.

## 6.8 Remove blockages

If the pressure in the fluidic system exceeds a certain level, the pump is stopped. Excessive pressure in the system can be caused by a blockage in the solvent tubes, the probe tip, the needle, the valve or in the pump itself. The error message "Fluid flow path is blocked" indicates a blockage in the system.

The EasySampler Pump Rinsing Set (30466882) is needed to perform the following tasks.

Perform at least one flush of the pump as described in [Rinse the pump Page 22] before performing the tasks in the following chapters.

If the error message does not disappear, an exchange of the tubing of the EasySampler might be needed, see chapter [Replace EasySampler 1210 Tubing Page 33].

### 6.8.1 Determine location of blockage

Isolate the EasySampler system by removing the probe from the fluid path.

- 1 Disconnect both probe solvent tubes from the EasySampler system.
- 2 Leave the electrical connection installed.
- 3 Install the bypass tube.
- 4 Start a **Clean** process from the touchscreen.
  - ➔ If the Clean process runs without error – the blockage is in the probe.
- 5 Press Abort Cleaning on EasySampler touchscreen and go to [Remove blockage in the probe Page 44]
- 6 If the error message "Fluid flow path is blocked" appears again, the blockage is in the EasySampler system. Go to [Remove blockage in the Solvent tubes, needle or valve Page 45]



### 6.8.2 Remove blockage in the probe

- 1 Remove the bypass.
- 2 Reconnect the probe solvent tubes as follows: black tube to grey port and grey tube to black port.
- 3 Start a **Clean** process from the touchscreen.
  - ➔ If the **Clean** process runs without error the blockage has been removed.
  - ➔ If the error occurs again the blockage has not been removed. Clean the solvent tubes by following the sequences below.
- 4 Reconnect solvent lines correctly.



### Clean solvent tubes in conduit

Using EasySampler Pump Rinsing Set (P/N 30466882) flush all solvent tubes in the probe conduit with solvent.

- 1 Disconnect the sampling probe from EasySampler system.
- 2 Disconnect the fittings at the top of the sampling probe.
- 3 Connect the syringe with the luer adapter to one of the tubes.
- 4 Place the other end into a waste receptacle and flush solvent through it.
- 5 Repeat these steps for the second tube.
- 6 Replace any tubing that is blocked.

For more instructions on changing conduit tubing go to [mt.com\EasySampler](http://mt.com\EasySampler). Select the Support tab and watch the video: Change Tubing in the Original EasySampler Probe Conduit

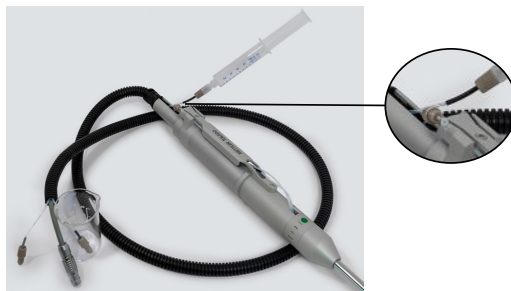

### Clean solvent tubes in probe

- 1 Connect the syringe with the luer adapter and the tube provided to one of the tubes leading to the probe shaft.
- 2 Place the other end into a vessel and flush solvent through it.

For more instructions on changing conduit tubing go to [Replacing the EasySampler probe head tubing Page 36]



### 6.8.3 Remove blockage in the Solvent tubes, needle or valve

- 1 Disconnect the needle and start a **Clean** process.
- 2 If the needle is unblocked but the error appears again when running a **Clean**, flush the solvent tube located between the syringe the black probe port.
- 3 If the solvent tube is unblocked but the error appears again when running a **Clean**, flush the remaining solvent tubes individually. If the blockage cannot be flushed out, exchange the entire tube.
- 4 If all solvent tubes are unblocked but the error appears again when running a **Clean**, flush solvent through the EasySampler valve.
- 5 Disconnect the tube from the pump to the valve and use the "EasySampler Pump Rinsing Set" for the flush.

### 6.9 Touchscreen Firmware Update

An empty USB stick is required to perform the firmware update.

Download the current version of the touchscreen firmware from <https://community.autochem.mt.com>. Login and navigate to products -> Software -> Other Software and Firmware.

You can find a how to video on [mt.com\EasySampler](http://mt.com\EasySampler) under the Support tab: Update EasySampler Firmware.

Description	Sequence
1 Download the .zip archive containing the software and extract the folder to an empty USB stick.	

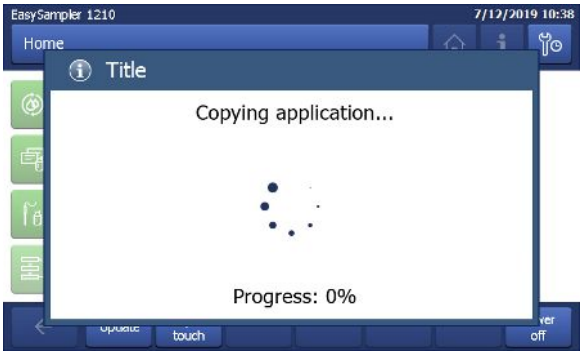
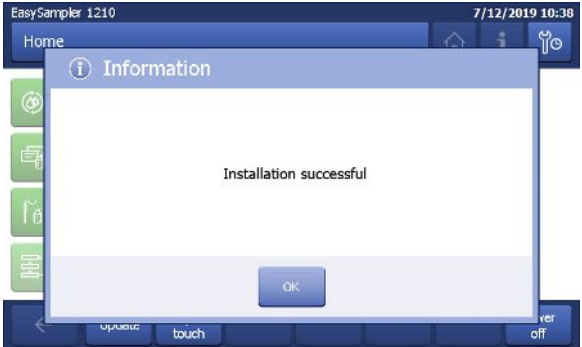
<ol style="list-style-type: none"> <li>2 Switch off EasySampler 1210.</li> <li>3 Remove the dongle before the firmware update.</li> <li>4 Insert the USB stick into any USB port of EasySampler 1210.</li> <li>5 Switch on EasySampler 1210.</li> <li>6 Select <b>Update</b>.</li> <li>7 Tap <b>OK</b> to accept the EULA (end user license agreement).</li> </ol>	 <p>The screenshot shows the 'Home' screen of the EasySampler 1210. At the top, it says 'EasySampler 1210' and '7/12/2019 10:38'. Below the title bar, there are two green boxes with icons and text. The first box shows 'Firmware on Device' with 'Product: EasySampler 1210', 'Variant: None', and 'Version: 5.5.0.0'. The second box shows 'Firmware on USB Stick' with 'Product: EasySampler 1210', 'Variant: None', and 'Version: 6.1.0.0'. At the bottom, there are buttons for 'Update', 'Adjust touch', and 'Power off'.</p>
<ol style="list-style-type: none"> <li>8 Wait until the installation is completed, this will take several minutes.</li> </ol> <p><b>Note</b> Do not remove the USB stick until the firmware update is completed.</p>	 <p>The screenshot shows the 'Home' screen with a dialog box titled 'Title' overlaid. The dialog box contains the text 'Copying application...' and a progress indicator showing 'Progress: 0%'. The background shows the same home screen as the previous screenshot.</p>
<ol style="list-style-type: none"> <li>9 The firmware update has been installed successfully.</li> <li>10 Select <b>OK</b>.</li> <li>11 Press <b>Power off</b>.</li> <li>12 Remove the USB stick.</li> <li>13 Switch on EasySampler 1210.</li> <li>14 Insert the dongle again in a USB port of the EasySampler 1210.</li> </ol>	 <p>The screenshot shows the 'Home' screen with an 'Information' dialog box overlaid. The dialog box contains the text 'Installation successful' and an 'OK' button. The background shows the same home screen as the previous screenshots.</p>

## 6.10 Disposal

In conformance with the European Directive 2012/19/EU on Waste Electrical and Electronic Equipment (WEEE) this device may not be disposed of in domestic waste. This also applies to countries outside the EU, per their specific requirements.

Please dispose of this product in accordance with local regulations at the collecting point specified for electrical and electronic equipment. If you have any questions, please contact the responsible authority or the distributor from which you purchased this device. Should this device be passed on to other parties, the content of this regulation must also be related.





## 7 Troubleshooting

Error messages	Cause	Steps to resolve
Air in feeding lines	The bubble detector (before the pump) has detected bubbles due to:	<p>Correct the error as described below</p> <ul style="list-style-type: none"> <li>• Check which cause might be responsible and correct according to proposed solution.</li> <li>• Press the '<b>Acknowledge messages</b>' button for a new initialization.</li> <li>• Run <b>Clean</b> process on EasySampler 1210, and then a <b>Prepare</b> process.</li> </ul>
	<b>1</b> At least 1 solvent feed bottle is empty, or the tubing end tip is above the solvent level.	Check the feed bottles and fill with solvent. Ensure the end tip of the PTFE tubing is below the solvent level.
	<b>2</b> Air is getting in the lines because: <ul style="list-style-type: none"> <li>• A fitting is loose or damaged</li> <li>• The tubing is damaged.</li> </ul>	<ul style="list-style-type: none"> <li>• Remove the back cover of EasySampler 1210 and check that all the fittings are connected properly and tightly (an audible click must be heard to confirm a fitting is tight).</li> <li>• Inspect the tubing for any holes or crimps and replace any damaged tubing.</li> </ul>
	<b>3</b> The bubble detector is wet (if there is a leak from the valve fittings the bubble detector may be wet)	Gently pull the PTFE tubing out of the bubble detector and dry the bubble detector with a piece of dry paper towel. Be sure the paper towel reaches where the tubing seats.
	<b>4</b> Bubble detector is dirty	Gently pull the PTFE tubing out of the bubble detector and clean the bubble detector with a dry piece of paper towel. If the bubble detector was wet, check the connections to the valve and pump to ensure there are no leaks.
	<b>5</b> Solvent is degassing	Some solvents, or combination of solvents, degas in the tubing. It is recommended to degas (sparging, sonication, filtration) the solvents prior to use with EasySampler 1210.
No vial detected	There is no vial in the rack into which to deposit the current sample.	<ol style="list-style-type: none"> <li>1. Press the 'Acknowledge messages' button.</li> <li>2. The needle moves up the highest position (change rack position).</li> <li>3. Remove the rack and insert vials.</li> <li>4. Place a rack on the table and press the '<b>Needle down</b>' button. The table will rotate to initialize and return to position Waste 1.</li> </ol> <p><b>Note</b> Current sample is deposited to waste.</p>
Fluid flow path is blocked	Pressure in the fluid lines is above 6 bar and the pump can no longer pump	<p>Determine where the blockage is.</p> <p>Refer to chapter [Remove blockages Page 44]</p>
Probe pocket is not moving	Probe pocket is not moving in or out <ul style="list-style-type: none"> <li>• Electrical connection issue</li> <li>• Probe motor is not working</li> </ul>	<ol style="list-style-type: none"> <li>1. Check the sampling probe connection to EasySampler 1210.</li> <li>2. Press the '<b>Acknowledge messages</b>' button for a new initialization.</li> <li>3. If the problem persists, call a service engineer.</li> </ol>
Tower is not moving	Tower is not moving up or down	<ol style="list-style-type: none"> <li>1. Check the tower for a mechanical arresting.</li> <li>2. Check that there are no items obstructing the tower movement.</li> <li>3. Press the '<b>Acknowledge messages</b>' button for a new initialization.</li> <li>4. If the problem persists, call a service engineer.</li> </ol>

No rack detected	The rack has not been placed on EasySampler 1210 table	<ol style="list-style-type: none"> <li>1. Press the 'Acknowledge messages' button.</li> <li>2. The needle moves up the highest position (change rack position).</li> <li>3. Remove the rack and insert vials.</li> <li>4. Place a rack on the table and press the <b>'Needle down'</b> button. The table will rotate to initialize and complete the change rack process.</li> </ol> <p><b>Note</b> A <b>Prepare</b> process must be run before a sample can be taken.</p>
Table is not rotating	<p>Table is not rotating</p> <ul style="list-style-type: none"> <li>• There is an obstruction to the table's rotation.</li> <li>• Table motor is not functional.</li> <li>• Turntable's 'light barrier' is damaged.</li> <li>• Sensors are misaligned.</li> </ul>	<ol style="list-style-type: none"> <li>1. Check the rack for a mechanical arresting.</li> <li>2. Check that all vials are standard METTLER TOLEDO vials for EasySampler 1210 and that they are correctly inserted and seated into the rack.</li> <li>3. Press the <b>'Acknowledge messages'</b> button for a new initialization.</li> <li>4. If the problem persists, call a service engineer.</li> </ol>
Unexpected table position	Table has an unexpected position	<ol style="list-style-type: none"> <li>1. Press the <b>'Acknowledge messages'</b> button for a new initialization.</li> <li>2. If the problem persists, call a service engineer.</li> </ol>
Unexpected tower position	Tower has an unexpected position	<ol style="list-style-type: none"> <li>1. Press the <b>'Acknowledge messages'</b> button for a new initialization.</li> <li>2. If the problem persists, call a service engineer.</li> </ol>
Unexpected sampling probe position	Sampling probe is not connected or the connection is defective.	<ol style="list-style-type: none"> <li>1. Check the sampling probe electrical connection to EasySampler 1210.</li> <li>2. Press the <b>'Acknowledge messages'</b> button for a new initialization.</li> <li>3. If the problem persists, call a service engineer.</li> </ol>

**See also**

 Remove blockage in the probe Page 44

 Remove blockage in the Solvent tubes, needle or valve Page 45

## 8 FAQs

Question	Answer
Can I extend any solvent lines or cut pieces?	No, the length of the solvent lines is important. When cutting or extending lines the sampling procedure does not function correctly and there is a risk of losing samples! The solvent amount is calculated based on the length of the provided solvent lines.
Can I remove the rack by lifting up the needle?	Yes, to remove the rack press the <b>Needle up</b> button. After installing/ replacing the rack press the <b>Needle down</b> button.
How do I name the solvents for the method creation on EasySampler 1210?	When pressing the <b>Prepare</b> button, a new screen opens where Quench, Dilution and Reaction Solvents can be defined. <ul style="list-style-type: none"> <li>• <b>Quench solvent</b> - quench the reaction mixture inside the sample pocket.</li> <li>• <b>Dilution solvent</b> - dissolve and dilute the quenched sample to a an appropriate concentration (in the <b>Dilution Factor</b> range of 80 - 450).</li> <li>• <b>Reaction solvent</b> - cleans the sample pocket and the fluid lines after the sample is transferred to the vial and prepares the sampling probe to take the next sample. The <b>Reaction solvent</b> needs to be inert towards your reaction mixture because 20 <math>\mu</math>L of this solvent will be released into the reaction mixture when the pocket is moved out when taking a sample.</li> </ul>
My sample shows too low concentration of the reactor contents.	Adjust the <b>Dilution Factor</b> using a smaller value. The <b>Dilution Factor</b> is the number of times that the 20 $\mu$ L sample is diluted. A smaller <b>Dilution Factor</b> leads to a higher concentration of the sampled material in the vial.
My sample shows too high concentration of the reactor contents.	Adjust the <b>Dilution Factor</b> using a larger value. The <b>Dilution Factor</b> is the number of times that the 20 $\mu$ L sample is diluted. A smaller <b>Dilution Factor</b> leads to a higher concentration of the sampled material in the vial.
I suspect that not all of my sample is transferred from the sample pocket to the sample vial.	In order to have a complete transfer of the contents of the sample pocket to the vial, the contents need to be mixed and dissolved in the quench and solvents. For multi-phase systems, not only mixing but also dilution is required. This may require more time and more solvents than for homogeneous reactor contents. In such cases a larger <b>Dilution Factor</b> might be required. If in doubt check different dilution factors.
Air bubbles in feeding bottles, what should I do?	To avoid air bubbles in the fluid lines 3 measures can be taken: <ul style="list-style-type: none"> <li>• Ensure solvent feed bottles are full.</li> <li>• De-gas solvents (by sonication) before use.</li> <li>• Ensure all connectors are sufficiently tightened</li> </ul>
How can I store EasySampler 1210 if I do not need it for some days?	<ol style="list-style-type: none"> <li>1 Perform a <b>Clean</b> process with isopropanol or ethanol.</li> <li>2 Perform a second <b>Clean</b> process with isopropanol.</li> </ol> <p>➔ You can now store the EasySampler 1210.</p>

## 9 Accessories

### 9.1 Main Accessories Overview

#### EasySampler 10 mL Rack and vials

	Description	Order No.
	EasySampler 10 mL rack	30040993



	Vial (100 pieces), not assembled	30244745
	Vial (1000 pieces), not assembled	30111624



#### Needle

	Description	Order No.
	Needle	30041011



#### Waste Bottle

	Description	Order No.
	Waste bottle 500 mL GL55	30072069



	Screw cap for 500 mL waste bottle, GL55	30094594
---	---	----------



	Septum for GL55	30306192
---	-----------------	----------



## Solvent Bottle and Distributor Cap

	Description	Order No.
	Bottle 250 mL with cap, GL45	51191591
	Silicone rubber seal	51191170
	Distributor cap, GL45, 2 x GL14	51191972
	Screw cap GL14, with aperture	51190317
	Screw Cap GL14, without aperture	51190318



## Sleeve Mounting and Removal Tool (SMART)

	Description	Order No.
	Sleeve Mounting And Removal Tool incl. Torx key	30213880

## EasySampler Pump Rinsing Set

	Description	Order No.
	EasySampler Pump Rinsing Set <ul style="list-style-type: none"> <li>• 1x PTFE tubing</li> <li>• 1x Luer locker adapter</li> <li>• 1x Syringe (10 mL)</li> </ul>	30466882

## Tubing Sets

	Description	Order No.
	PTFE tube set to solvents	30246341
	PTFE tube set for EasySampler 1210	30246340

## 9.2 Probe and accessories

### Probe

	Description	Order No.
	EasySampler Probe 210 set	30246344
	EasySampler Probe 330 Set	30306933
	EasySampler Probe 450 set	30306037

### Sleeve

	Description	Order No.
	PTFE Sleeve	30100528

### Tube sets

	Description	Order No.
	Tube set for Probe 210	30247094
	Tube set for Probe 330	30246342
	Tube set for Probe 450	30306036
	Sleeve mounting clamp	30326844

## 10 Technical Data

Certifications regarding this product can be found at <https://www.mt.com/us/en/home/search/compliance.html/>  
The product name of your device is the model number.

### EasySampler 1210 System

Materials	Housing: Polypropylene PP 30% Talcum Tubing: PTFE Needle: Stainless steel Valve: Ceramic Pump: Ceramic, PTFE Protective foil touchscreen: polyester film
Power Connection	100...240 V; 50/60 Hz
User Interface	METTLER TOLEDO Touchscreen
Weight	9 kg, 20 lbs
Vials	10 mL, borosilicate glass
Rack	12 x 10 mL vials

### Ambient conditions

<b>Humidity</b>	Max. relative humidity 80 % for temperatures up to 31 °C decreasing linearly to 50 % relative humidity at 40 °C
<b>Altitude</b>	Up to 2000 m
<b>Overvoltage category</b>	II
<b>Pollution degree</b>	2
<b>Ambient temperature</b>	5 °C...40 °C
<b>Usage</b>	For indoor use only

### EasySampler Probe

	<b>210</b>	<b>330</b>	<b>450</b>
Weight	0.8 kg, 1.76 lbs	0.84 kg, 1.85 lbs	0.88 kg, 1.94 lbs
Length	213 mm / 8.38"	333 mm / 13.11"	453 mm / 17.83"
Materials	Wetted parts: Alloy C-22, PTFE Non-wetted parts: Anodized aluminum, stainless steel		
Pocket Size	20 µL ±10%		
Temperature Range	-20 °C to 140 °C (for reactions at atmospheric pressure)		
Pressure	1.013 bar to 10 bar, 14.7 psi to 145 psi with the following conditions: <ul style="list-style-type: none"> <li>• Temperature range: 20 °C to 100 °C</li> <li>• Maximum reactor volume: 2500 mL</li> </ul>		
Recommended sleeve change	<ul style="list-style-type: none"> <li>• At ambient pressure: every 100 samples</li> <li>• At elevated pressure: after each experiment or 24 samples (maximum 24 samples per reaction)</li> </ul>		
Minimum Sampling Interval	2 min 52 sec		
pH	1 to 14		

**Supported Firmware and Software for Connectivity kit****Touchscreen to Touchscreen Control:**

EasySampler: Firmware Version 1.1.0.0 or higher  
EasyMax, OptiMax and RX-10: Firmware Version 5.4.0.0 or higher

**Compatibility with iControl Software:**

EasySampler: Firmware Version 5.5.0.0 or higher  
EasyMax, OptiMax and RX-10: Firmware Version 5.5.0.0 or higher

iControl: Software Version 5.5 or higher

## 10.1 Solvent compatibility

The materials of construction are listed in the technical data (above). When selecting solvents, ensure they are compatible with all the wetted parts of EasySampler 1210 and also the sampling probe.

## 10.2 Dimensions

### 10.2.1 Device Dimensions

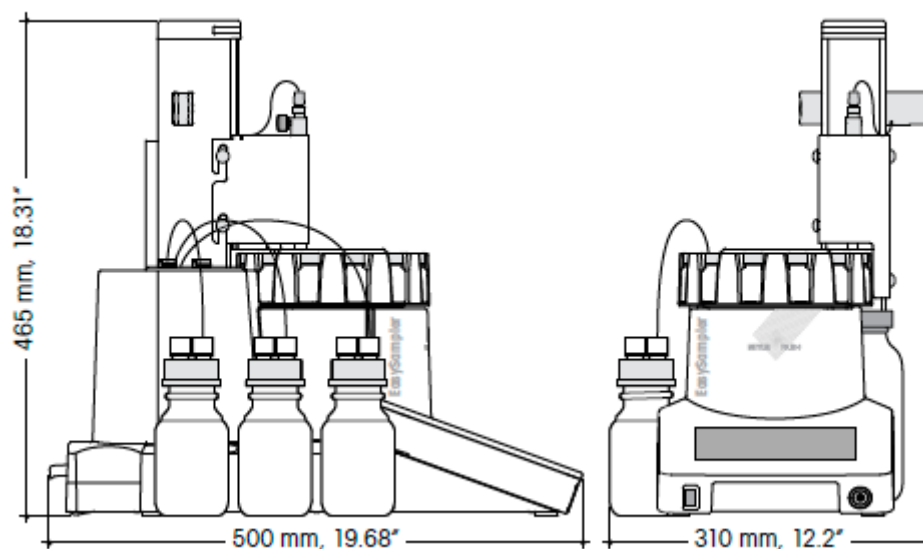

### 10.2.2 Probe Dimensions

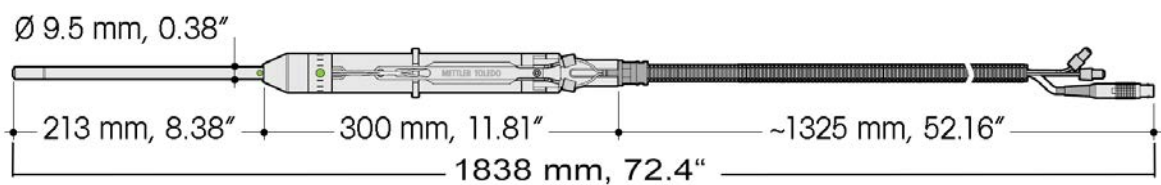
**Probe 210****Probe 330**



**Probe 450**

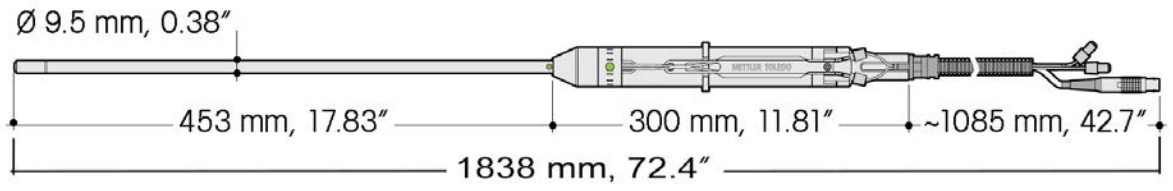

## 11 Certifications

### 11.1 Information\_Notice\_EasySampler\_Pressure Directive\_2014\_68\_EU.pdf

# Information Notice

## Manufacturing of Pressure Assemblies

In reference to 2014/68/EU

**Pressure Assemblies:** EasySampler Probe 450 (part number: 30279540)  
EasySampler Probe 330 (part number: 30306934)  
EasySampler Probe 210 (part number: 30043400)

**Manufacturer:** Mettler Toledo GmbH, Im Langacher, Greifensee (CH)

**Product Specifications at elevated pressure**

Maximum / Minimum specified Pressure (PS)	10 bar / 1.013 bar
Maximum / Minimum specified Temperature (TS)	100 °C / 20 °C
Maximum Reactor Volume applied:	2500 mL
Nominal Size of EasySampler Probe (DN)	< 6

**Safety Equipment:** None

**Classification according directive 2014/68/EU** Annex II/Chapter 4 Paragraph 3

**Conformity Assessment Procedure**

The listed pressure assemblies are outside the scope of directive 2014/68/EU, Chapter 1, Article 1, 2(f) with reference to Article 13 and in accordance with Annex II of this directive. Design specification, manufacturing and testing has been conducted in accordance with the sound engineering practice in order to ensure safe use. Applied parameters in product testing: 20 to 110 °C temperature range, 17.5 bar pressure, reactor volume of 100 mL.

**CE Labeling**

According to chapter 4 (3) of the directive 2014/68/EU the listed pressure assemblies shall not bear the CE marking referred to in the directive 2014/68/EU.

Instructions for safe use are included in the EasySampler operating instructions.

Date and Location

Manufacturer

Signature

May, 17 2016 Schwerzenbach

METTLER TOLEDO



Head Strategic Product Group CSS

**METTLER TOLEDO**



**To protect your product's future:**  
METTLER TOLEDO Service assures  
the quality, measuring accuracy and  
preservation of value of this product  
for years to come.

Please request full details about our  
attractive terms of service.

[www.mt.com/EasySampler](http://www.mt.com/EasySampler)

For more information

**Mettler-Toledo GmbH**

Im Langacher 44  
8606 Greifensee, Switzerland  
[www.mt.com/contact](http://www.mt.com/contact)

Subject to technical changes.  
© Mettler-Toledo GmbH 02/2021  
30091777D



30091777